

Product Guide

Compression and Tension Adapters



Importance of Adapters for Force Calibration

When using the right adapters, calibration technicians have the highest probability of meeting the requested specifications. Keeping the line of force pure or free from eccentric forces is key. Not using the proper adapters to calibrate force-measuring devices can produce significant measurement errors and pose serious safety concerns..

No matter how good an operator may be, they are no match for a precision machined adapter. When they must use tools to center everything, it takes extra time to measure, center, and measure again before they start the calibration.

Morehouse adapters standardize the calibration process, simplify setup, improve cycle time, reduce errors, and improve safety. They are designed and manufactured according to guidelines in the ISO 376 standard and are available in multiple capacities and sizes. For more information, read [Recommended Compression and Tension Adapters for Force Calibration](#).



Calibration Technician Aligning a Load Cell with Adapters

Table of Contents

Calibrating Machine / Adapter Key	6
Compression Adapter Assembly (Reference Standard)	
UC-xxx-51 (UCM Ball Seat Adapter)	7
CCE-1 (Load Ball Adapter)	7
CA (Alignment Plug)	7
UC-xxx-50 (UCM Jack Compression Block)	7
Compression Adapter Assembly (UUT)	
UC-xxx-52 (UCM Lower Yoke Compression Block)	8
UC-xxx-51 (UCM Upper Yoke Compression Block - capacity 200k & higher)	8
CG-3 (Top Compression Alignment Block - threaded)	9
CG-10 (Top Compression Alignment Block - for UCM)	9
CG-15 (Upper Alignment Bushing Plate)	9
Load pad/bearing block assembly for Compression	
UC-xxx-53 (UCM Bearing Block - capacity 200k lbf and higher)	10
CF-1 (Load Pad)	10
Thread Specific Adapters for Compression	
CH-1 (Internal Ball Adapter - threaded stud)	11
CH-2 (Internal Ball Adapter - smooth shaft)	11
Field Application of Compression Adapters	
CI-1 (ISO Compression Adapter - on top of spherical surface)	12
CI-2 (ISO Compression Adapter - base)	12
CN-1 (Thread Loading Base)	12
CB-1 (Spherical Load Button - wrench flat)	13
CB-2 (Spherical Load Button - spanner holes)	13
CB-3 (Spherical Load Button - smooth shaft)	13
CB-5 (Spherical Load Button - shoulderless)	13
CG-1 (Top Compression Alignment Block - straight edge)	14
CM (Compression Base Block)	14
CL (L-Bracket)	15



Miniature Load Cell Adapter Set for Compression

CPD (Miniature Load Cell Adapter Set) 16

CD-1 (Miniature Ball Adapter for Button Load Cell) 16

CD-2 (Miniature Ball Adapter for Washer Load Cell) 16

CP (Miniature Cell Base Adapter) 16

Tension Member Adapter Assembly

TMA (Tension Member Assembly) 17

TA-M (Tension Member Assembly Male Threaded Adapter) 17

TA-F (Tension Member Assembly Female Threaded Adapter) 17

Clevis Assembly for Tension

TUA (Tension Clevis Assembly) 18

TP (Straight Pin) 18

TUZ (Clevis Shoulder Pin Assembly) 18

TX (Clevis Pin Roller) 18

Tension Rod Ends

ZM (Rod Ends for Force Ring Gauges) 19

TD-1 (Rod Ends for Load Cells) 19

Adapters Reduce Measurement Error 20

Alphabetical Adapter Index

CA (Alignment Plug)	7
CB-1 (Spherical Load Button - wrench flat)	13
CB-2 (Spherical Load Button - spanner holes)	13
CB-3 (Spherical Load Button - smooth shaft)	13
CB-5 (Spherical Load Button - shoulderless)	13
CCE-1 (Load Ball Adapter)	7
CD-1 (Miniature Ball Adapter for Button Load Cell)	16
CD-2 (Miniature Ball Adapter for Washer Load Cell)	16
CF-1 (Load Pad)	10
CG-1 (Top Compression Alignment Block - straight edge)	14
CG-3 (Top Compression Alignment Block - threaded)	9
CG-10 (Top Compression Alignment Block - for UCM)	9
CG-15 (Upper Alignment Bushing Plate)	9
CH-1 (Internal Ball Adapter - threaded stud)	11
CH-2 (Internal Ball Adapter - smooth shaft)	11
CI-1 (ISO Compression Adapter - on top of spherical surface)	12
CI-2 (ISO Compression Adapter - base)	12
CL (L-Bracket)	15
CM (Compression Base Block)	14
CN-1 (Thread Loading Base)	12
CP (Miniature Cell Base Adapter)	16
CPD (Miniature Load Cell Adapter Set)	16
TA-F (Tension Member Assembly Female Threaded Adapter)	17
TA-M (Tension Member Assembly Male Threaded Adapter)	17
TD-1 (Rod Ends for Load Cells)	19
TMA (Tension Member Assembly)	17
TP (Straight Pin)	18
TUA (Tension Clevis Assembly)	18
TUZ (Clevis Shoulder Pin Assembly)	18
TX (Clevis Pin Roller)	18
UC-xxx-50 (UCM Jack Compression Block)	7
UC-xxx-51 (UCM Ball Seat Adapter)	7
UC-xxx-51 (UCM Upper Yoke Compression Block - capacity 200k & higher)	8
UC-xxx-52 (UCM Lower Yoke Compression Block)	8
UC-xxx-53 (UCM Bearing Block - capacity 200k lbf and higher)	10
ZM (Rod Ends for Force Ring Gauges)	19

Calibrating Machine / Adapter Key

The adapters in this guide are designed for specific calibrating machines. They are available in multiple capacities and sizes. The color key below is used throughout the guide to identify the type of machine where each adapter can be used.

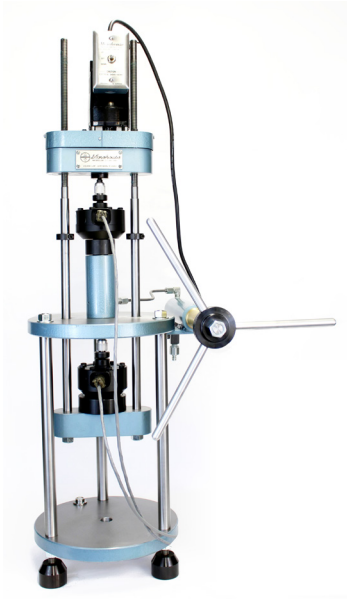

■ Universal Calibrating Machine



■ Deadweight Calibrating Machine



■ Mechanical Tensiometer Calibrator



■ Benchtop Calibrating Machine

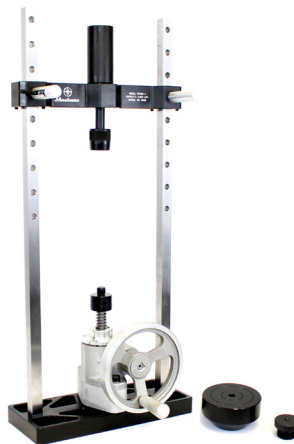

■ Portable Calibrating Machine



■ Non-Morehouse Machines



Adapters are available in multiple capacities and sizes



Compression Adapter Assembly (Reference Standard)

1. Upper yoke platen
2. Ball seat adapter (UC-xxx-51)
3. Load ball adapter (CCE-1)
4. Load cell (reference standard)
5. Alignment plug (CA)
6. Jack compression block (UC-xxx-50)
7. Hydraulic jack

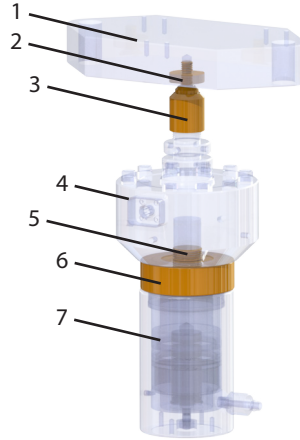

UCM Ball Seat Adapter (UC-xxx-51) ■

One threads into the upper yoke platen for the reference standard, and one threads into the upper fixed platen for the unit under test. The load ball adapter (CCE-1) connects to the bottom of each. xxx in the part number designates the Universal Calibrating Machine capacity.



Load Ball Adapter (CCE-1) ■■■■

The load ball adapter connects to the UCM ball seat adapter (UC-xxx-51) and threads onto the load cell to provide alignment. It can be used for the reference standard or unit under test.

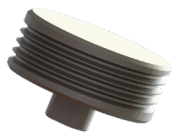

Alignment Plug (CA) ■■■■

The alignment plug threads into the load cell and helps center it in a calibrating machine. It is used in combination with the UCM jack compression block (UC-xxx-50) and UCM Lower Yoke Compression Block (UC-xxx-52).

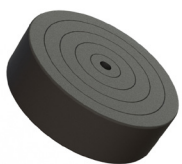

UCM Jack Compression Block (UC-xxx-50) ■

The jack compression block is used for the reference standard and sets into the hydraulic jack. The alignment plug (CA) sets into the block. xxx in the part number designates the Universal Calibrating Machine capacity.



Compression Adapter Assembly (UUT)

1. Upper machine platen
2. UCM upper yoke compression block - capacity 200 klb & higher (UC-xxx-51)
3. High capacity multi-column load cell
4. Alignment plug (CA)
5. UCM lower yoke compression block (UC-xxx-52)
6. Lower yoke

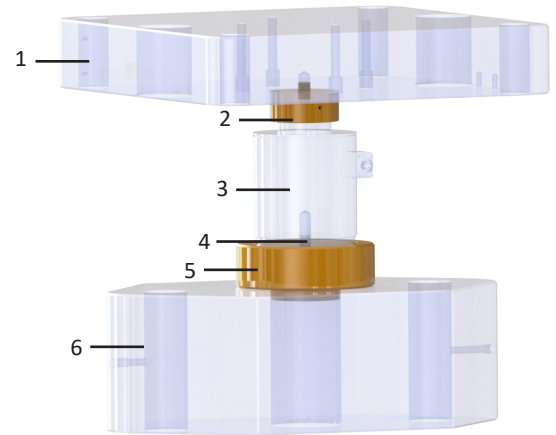

UCM Upper Yoke Compression Block - capacity 200 klb & higher (UC-xxx-51) ■

The adapter connects to the bottom surface of the upper yoke for Universal Calibrating Machines of capacity 200k and higher. xxx in the part number designates the Universal Calibrating Machine capacity.



UCM Lower Yoke Compression Block (UC-xxx-52) ■

The lower yoke compression block ensures the unit under test setup is centered on the lower yoke platen and protects it from deformation. The alignment plug (CA) sets into the block. xxx in the part number designates the Universal Calibrating Machine capacity.



Calibrating Machine / Adapter Key (see page 6 for more details)

- | | | |
|---------------------------------|----------------------------------|-------------------------------------|
| ■ Universal Calibrating Machine | ■ Deadweight Calibrating Machine | ■ Mechanical Tensiometer Calibrator |
| ■ Benchtop Calibrating Machine | ■ Portable Calibrating Machine | ■ Non-Morehouse Machines |

Compression Adapter Assembly (UUT)

1. Upper machine platen
2. Top compression alignment block - for UCM (CG-10)
3. Upper alignment bushing plate (CG-15)
4. Spherical load button (CB series)
5. High capacity multi-column load cell
6. Alignment plug (CA)
7. UCM lower yoke compression block (UC-xxx-52)
8. Lower yoke bearing plate

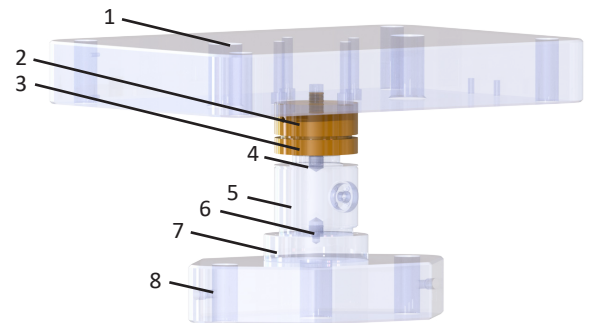

Top Compression Alignment Block - for UCM (CG-10) ■

This adapter can be used with any load cell terminating with a compression load button. It can be used with a spherical load button (CB-1, CB-2, CB-3, CB-5) to align the unit under test or reference standard. It has an adjustable design that accommodates various upper alignment bushing plates (CG-15) for different diameter load cells.

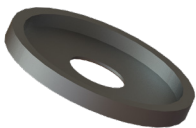

Upper Alignment Bushing Plate (CG-15) ■

A bushing plate is used with the top compression alignment block (CG-10) to adjust to different diameter load cells.





Load Pad/Bearing Block Assembly for Compression

1. Upper machine platen
2. UCM bearing block (UC-xxx-53)
3. Load pad (CF-1)

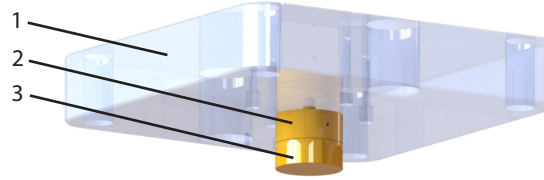

UCM Bearing Block - capacity 200k lbf and higher (UC-xxx-53) ■

Used in the upper platen, the UCM bearing block protects it from deformation. It can be used with a load pad (CF-1) for a load cell with a flat surface. xxx in the part number designates the Universal Calibrating Machine capacity.



Load Pad (CF-1) ■■■■■■

A load pad protects a load cell and contact area from deformation. It can be used with the bearing block (UC-xxx-53) to connect to the upper platen.



Calibrating Machine / Adapter Key (see page 6 for more details)

- | | | |
|---------------------------------|----------------------------------|-------------------------------------|
| ■ Universal Calibrating Machine | ■ Deadweight Calibrating Machine | ■ Mechanical Tensiometer Calibrator |
| ■ Benchtop Calibrating Machine | ■ Portable Calibrating Machine | ■ Non-Morehouse Machines |



Thread Specific Adapters for Compression



Internal Ball Adapter - threaded stud (CH-1) ■■■■■■

It can be used for shoulder or thread loading with a female threaded load cell. It can be used with the UCM ball seat adapter (UC-xxx-51).

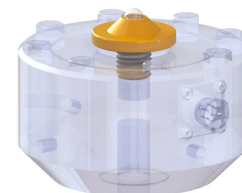

Internal Ball Adapter - smooth shaft (CH-2) ■■■■■■

The smooth shaft is designed for load cells with a through-hole design. It can be used with the UCM ball seat adapter (UC-xxx-51).

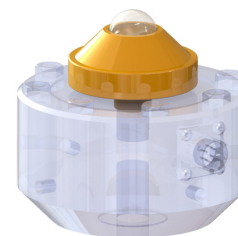



Field Application of Compression Adapters

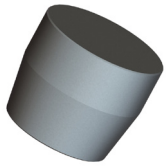

ISO Compression Adapter - on top of spherical surface (CI-1) ■ ■ ■ ■ ■ ■ ■

The ISO compression adapter is made for load cells with an external stud and spherical top.

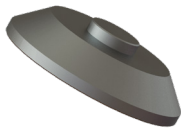

ISO Compression Adapter - base (CI-2) ■ ■ ■ ■ ■ ■ ■

The ISO compression adapter base is made for load cells with internal threads or smooth holes. It can be used as a base adapter with CI-1 on top of the load cell.



Thread Loading Base (CN-1) ■ ■ ■ ■ ■ ■ ■

The thread loading base has a flat conical shape and is made for load cells with internal threads. It can be used as a base adapter with CI-1 on top of the load cell.

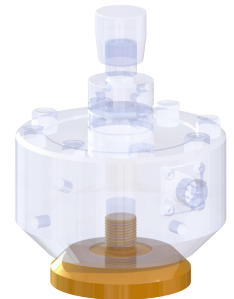

Calibrating Machine / Adapter Key (see page 6 for more details)

- Universal Calibrating Machine ■ Deadweight Calibrating Machine ■ Mechanical Tensiometer Calibrator
- Benchtop Calibrating Machine ■ Portable Calibrating Machine ■ Non-Morehouse Machines



Field Application of Compression Adapters



Spherical Load Button - wrench flat (CB-1) ■ ■ ■ ■ ■ ■

A spherical load button threads into the reference standard load cell and connects to the top compression alignment block (CG-1) to align the reference standard. It provides consistent loading for instruments requiring shoulder load.



Spherical Load Button - spanner holes (CB-2) ■ ■ ■ ■ ■ ■

A spherical load button threads into the reference standard load cell and connects to the top compression alignment block (CG-1) to align the reference standard. It provides consistent loading for instruments requiring shoulder load. The spanner holes allow for easy removal.

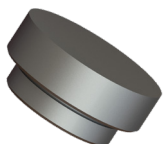

Spherical Load Button - smooth shaft (CB-3) ■ ■ ■ ■ ■ ■

Designed for load cells with a through-hole design, the spherical load button connects to a reference standard load cell and the top compression alignment block (CG-1) to align the reference standard.



Spherical Load Button - shoulder less (CB-5) ■ ■ ■ ■ ■ ■

Designed for load cells with a female thread, the spherical load button connects to a reference standard load cell and the top compression alignment block (CG-1) to align the reference standard. It is used for compression loading through the threads.





Field Application of Compression Adapters

1. Top compression alignment block - straight edge (CG-1)
2. Mini multi-column load cell
3. Compression base block (CM)

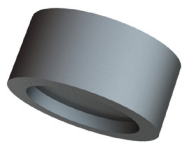
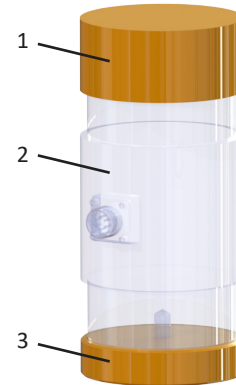

Top Compression Alignment Block - straight edge (CG-1) ■ ■ ■ ■ ■ ■

This adapter can be used with any load cell terminating with a compression load button. It can be used with a spherical load button (CB-1, CB-2, CB-3, CB-5) to align the reference standard.



Compression Base Block (CM) ■ ■ ■ ■ ■ ■

Made for concrete compression to help with load alignment. It includes alignment grooves for each load cell in the Concrete Compression Machine Calibration Kit.



Part Name	Part No.
Compression Base Block (no rings)	CM-1
Compression Base Block (one rings)	CM-2
Compression Base Block (two rings)	CM-3
Compression Base Block (three rings)	CM-4

Calibrating Machine / Adapter Key (see page 6 for more details)

- Universal Calibrating Machine
- Deadweight Calibrating Machine
- Mechanical Tensiometer Calibrator
- Benchtop Calibrating Machine
- Portable Calibrating Machine
- Non-Morehouse Machines



Field Application of Compression Adapters

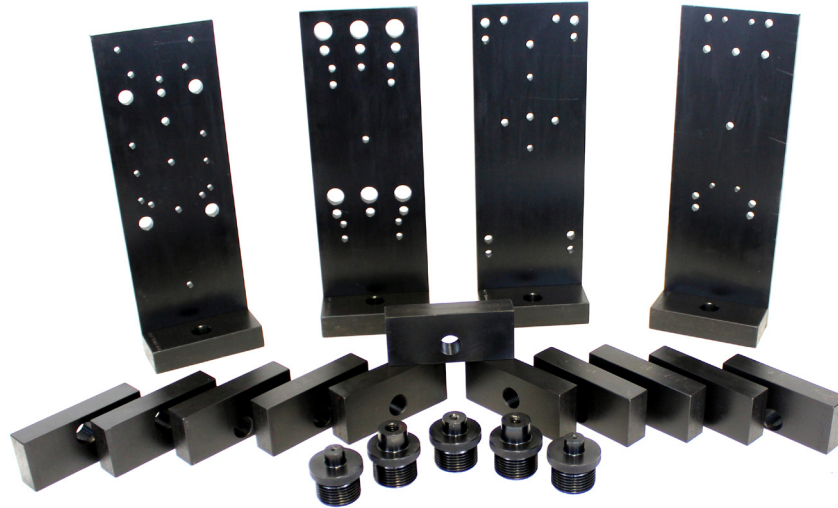

L-Bracket (CL) 

The L-Brackets are designed to calibrate handheld force gauges in a Portable Calibrating Machine. Use in other machines requires supporting adapters. The set of L-Brackets consists of a number of back plates, bottom plates, and threaded adapters to mount various models of handheld force gauges. Each back plate can be mounted to any of the bottom plates to make different combinations. They are designed with special hole patterns, which can accommodate different types of handheld force gauges available on the market.

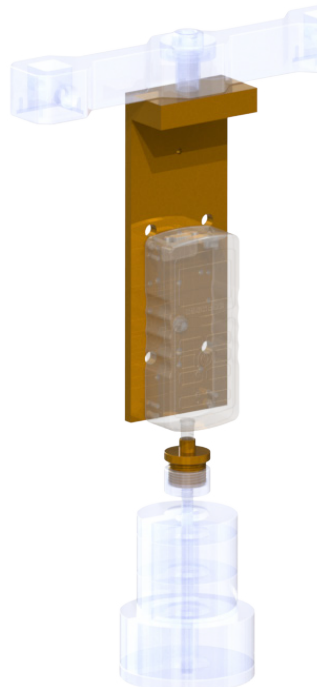



Miniature Load Cell Adapter Set (CPD) for Compression

1. Miniature ball adapter for button load cell (CD-1)
2. Miniature ball adapter for washer load cell (CD-2)
3. Button or washer load cell
4. Miniature cell base adapter (CP)

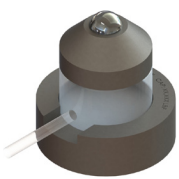
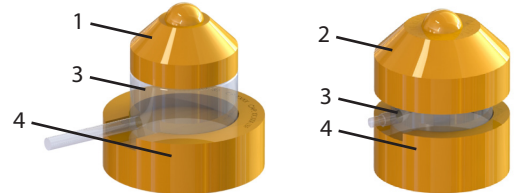

Miniature Load Cell Adapter Set (CPD) ■ ■ ■ ■ ■ ■

Adapter set designed for button load cell and washer load cell alignment. The set combines the miniature ball adapter for button load cell (CD-1) or miniature ball adapter for washer load cell (CD-2) with the miniature cell base adapter (CP) .



Miniature Ball Adapter for Button Load Cell (CD-1) ■ ■ ■ ■ ■ ■

Top adapter with loading ball provides compression load line alignment during calibration of button load cells. Use with miniature cell base adapter (CP).

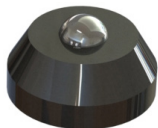

Miniature Ball Adapter for Washer Load Cell (CD-2) ■ ■ ■ ■ ■ ■

Top adapter with loading ball provides compression load line alignment during calibration of washer load cells. Use with miniature cell base adapter (CP).



Miniature Cell Base Adapter (CP) ■ ■ ■ ■ ■ ■

Bottom base fixture for button and washer load cells that provides compression load line alignment during calibration. It can be used with the miniature ball adapter for the button load cell (CD-1) or the washer load cell (CD-2)..

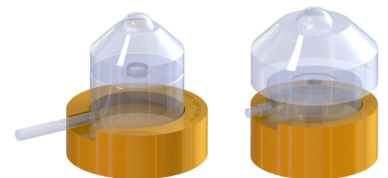

Calibrating Machine / Adapter Key (see page 6 for more details)

- | | | |
|---|--|---|
| ■ Universal Calibrating Machine | ■ Deadweight Calibrating Machine | ■ Mechanical Tensiometer Calibrator |
| ■ Benchtop Calibrating Machine | ■ Portable Calibrating Machine | ■ Non-Morehouse Machines |



Tension Member Adapter Assembly

1. Tension member assembly (TMA)
2. Lower yoke platen
3. Tension member assembly female-threaded adapter (TA-F)
4. Load cell
5. Tension member assembly male-threaded adapter (TA-M)
6. Tension member assembly (TMA)
7. Lower machine platen

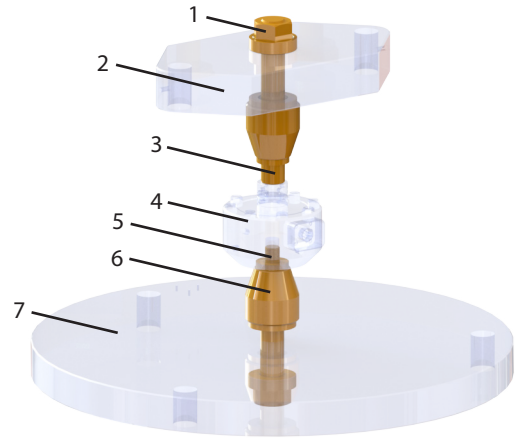

Tension Member Assembly (TMA) ■ ■

One tension member is installed on the lower yoke platen and one on the lower fixed platen. The built-in self-alignment features of the tension member assembly automatically align the applied force to the appropriate force line of the instrument.



Tension Member Assembly Male-Threaded Adapter (TA-M) ■ ■ ■ ■ ■ ■

The tension member connects the machine to other force-measuring instruments using this male-threaded adapter.



Tension Member Assembly Female-Threaded Adapter (TA-F) ■ ■ ■ ■ ■ ■

The tension member connects the machine to other force-measuring instruments using this female-threaded adapter.





Clevis Assembly for Tension

1. Tension member assembly (TMA)
2. Lower yoke platen
3. Tension clevis assembly (TUA) with straight pin (TP)
4. Dynamometer
5. Tension clevis assembly (TUA) with straight pin (TP)
6. Lower machine platen
7. Tension member assembly (TMA)

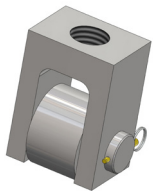
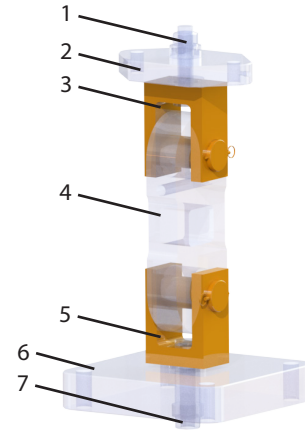

Tension Clevis Assembly (TUA) ■ ■ ■ ■ ■ ■

A clevis assembly is attached to a Tension Member through the retaining ring after removing the coupling nut or with an intermediate threaded adapter, which attaches to the coupling nut. The clevis assembly consists of a clevis, a straight pin or shoulder pin, and a detent pin.

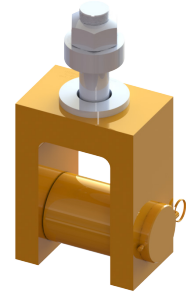

Straight Pin (TP) ■ ■ ■ ■ ■ ■

The straight pin is the standard pin included with a tension clevis assembly (TUA). It is designed and manufactured to fit the side holes on the clevis.

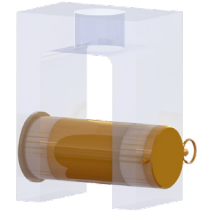

Clevis Shoulder Pin Assembly (TUZ) ■ ■ ■ ■ ■ ■

The clevis shoulder pin can be used with the tension clevis assembly (TUA) instead of the straight pin (TP). It includes a bushing and is often used to generate pin sizes with smaller diameters than the straight pin.

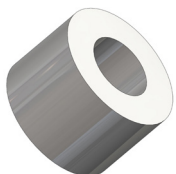
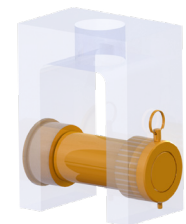

Clevis Pin Roller (TX) ■ ■ ■ ■ ■ ■

The clevis pin roller can be used with a straight pin (TP) or shoulder pin (TUZ) to protect the pin against concentrated forces. For instruments calibrated with loading shackles, it is placed between the clevis pin and shackles. The roller transfers the force to a larger surface area on the clevis pin and prevents damage.





Tension Rod Ends



Rod Ends for Force Ring Gauges (ZM)

For ring force gauges, a set of two rod ends can be used to measure tensile forces and help with tensile load line alignment.

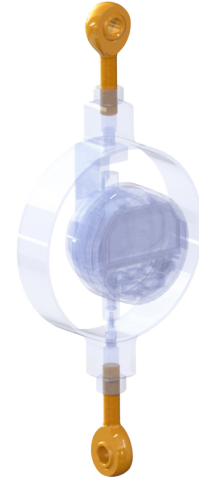

Rod Ends for Load Cells (TD-1)

For load cells, a set of two rod ends can be used to measure tensile forces and help with tensile load line alignment.



Calibrating Machine / Adapter Key (see page 6 for more details)

- | | | |
|--|---|--|
| Universal Calibrating Machine | Deadweight Calibrating Machine | Mechanical Tensiometer Calibrator |
| Benchtop Calibrating Machine | Portable Calibrating Machine | Non-Morehouse Machines |

Adapters Reduce Measurement Error

Morehouse has created these adapters to standardize the calibration process, simplify setup, improve cycle time, reduce errors, and improve safety. The output of a force-measuring device can be significantly impacted by adapters, which poses serious safety concerns and can impact measurement uncertainty. Risk considerations include:

- Lifespan of old adapters
- Eccentric force and side loading
- Permanent material deformation
- Not using ISO 376 recommendations for tension loading
- Introducing unwanted bending or torsion
- Calibration setups that do not replicate the application, such as:

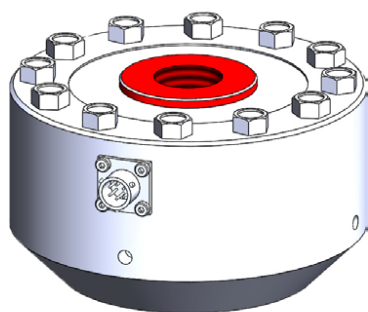

Varying thread engagement

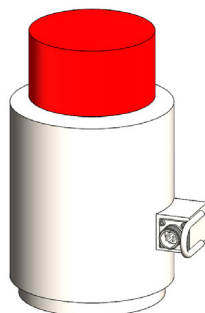

Varying hardness and flatness
of top adapters

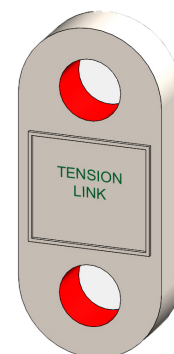

Varying pin size

Force calibration can be complex because the mechanical interactions of not using the proper adapters can produce significant errors. We welcome the opportunity to help reduce these errors by answering your questions or concerns.

For more information, read:

[Recommended Compression and Tension Adapters for Force Calibration](#)

[Common Measurement Errors in Weighing](#)

[Conditions, Methods, and Systems that Impact Force Calibration](#)